

cc-by-sa  
 Olivier Gillet  
 ol.gillet@gmail.com

Digital section	
tides_v40	
8/28/17 5:40 PM	
Sheet: 1/3	

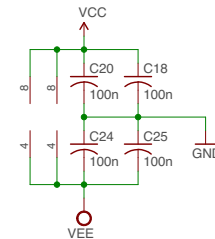
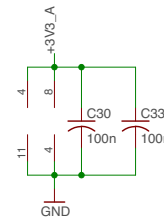
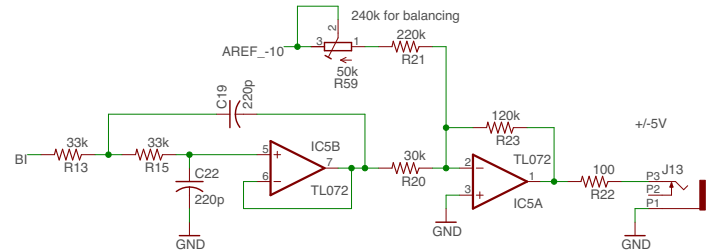
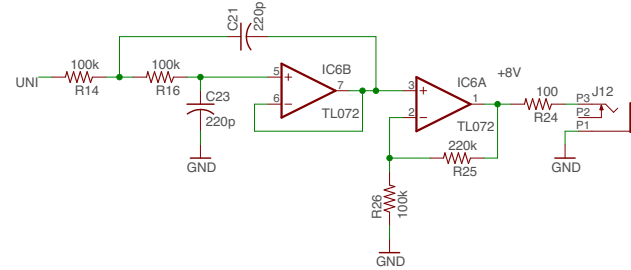
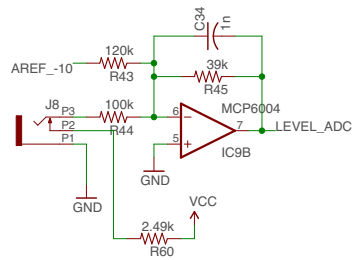
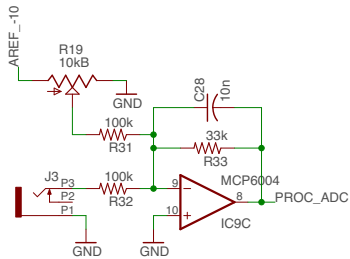
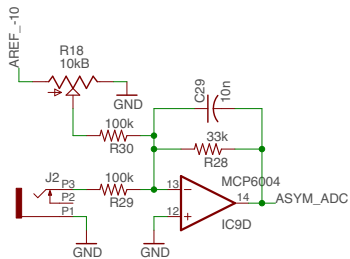
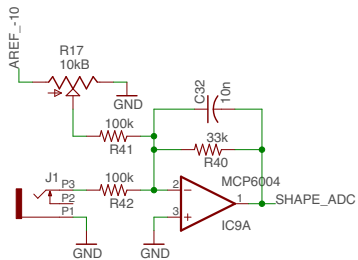
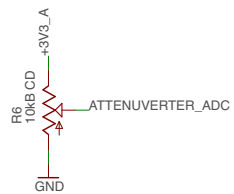
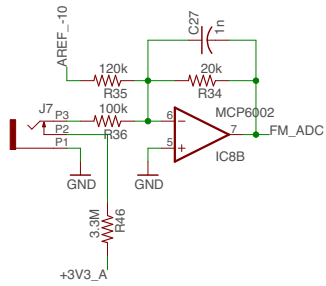
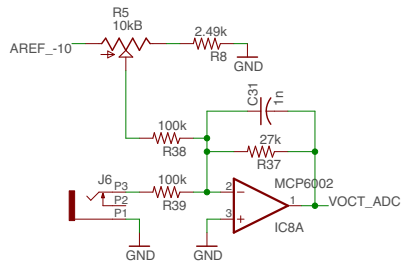

cc-by-sa  
Olivier Gillet  
ol.gillet@gmail.com

Analog Section  
tides\_v40  
8/28/17 5:40 PM  
Sheet: 2/3

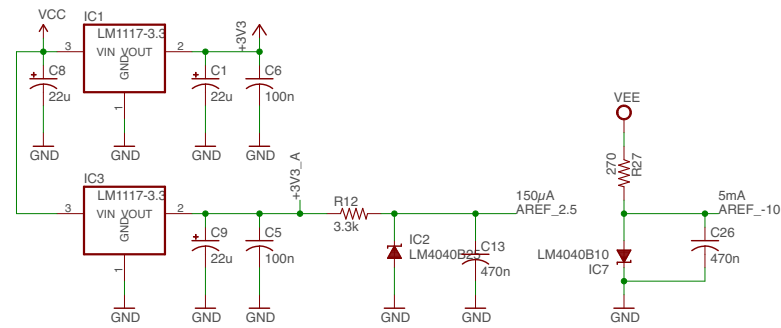
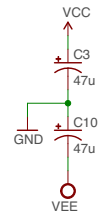
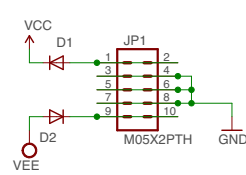

cc-by-sa	Power supply
Olivier Gillet	tides_v40
ol.gillet@gmail.com	8/28/17 5:40 PM
	Sheet: 3/3